

JIFI2018
JORNADAS DE INVESTIGACIÓN
ENCUENTRO ACADÉMICO INDUSTRIAL
FACULTAD DE INGENIERÍA UCV

Inspección y Proceso Constructivo de Fundaciones Profundas



PILOTES **KS**

GEO CONSTRUCCIONES Y MAQUINARIAS C.A

TRANSMITIR LOS CONOCIMIENTOS PARA REALIZAR UNA ADECUADA Y CORRECTA INSPECCION EN LA EJECUCION DE PILOTES APLICANDO LOS PROCEDIMIENTOS CONSTRUCTIVOS QUE GARANTIZAN LA CALIDAD DEL PRODUCTO.

CONTENIDO

- ✓ CONCEPTO BASICO FUNDACIONES PROFUNDAS
- ✓ DONDE SE AMERITA USO PILOTES
- ✓ TIPO DE PILOTES Y SU COMPARACION
- ✓ DOCUMENTOS TECNICOS EN OBRA
- ✓ PILOTES CIRCULARES PERFORADOS
- ✓ CONDICIONES DE ARMADURAS DE REFUERZO
- ✓ PREVENCIONES EN EL VACIADO DEL PILOTE CON CONCRETO
- ✓ PROCEDIMIENTOS DE CONTROL DE CALIDAD

Fundaciones Profundas

“Conceptos”

TODO ELEMENTO EXCAVADO O PERFORADO VACIADO EN SITIO, HINCADO Y QUE ES CAPAZ DE SOPORTAR CARGAS VERTICALES.

TODO ELEMENTO DE FUNDACIÓN CON UNA RELACIÓN

$$D/B \geq 5$$

“D” es la longitud del pilote

“B” el Diámetro del Pilote

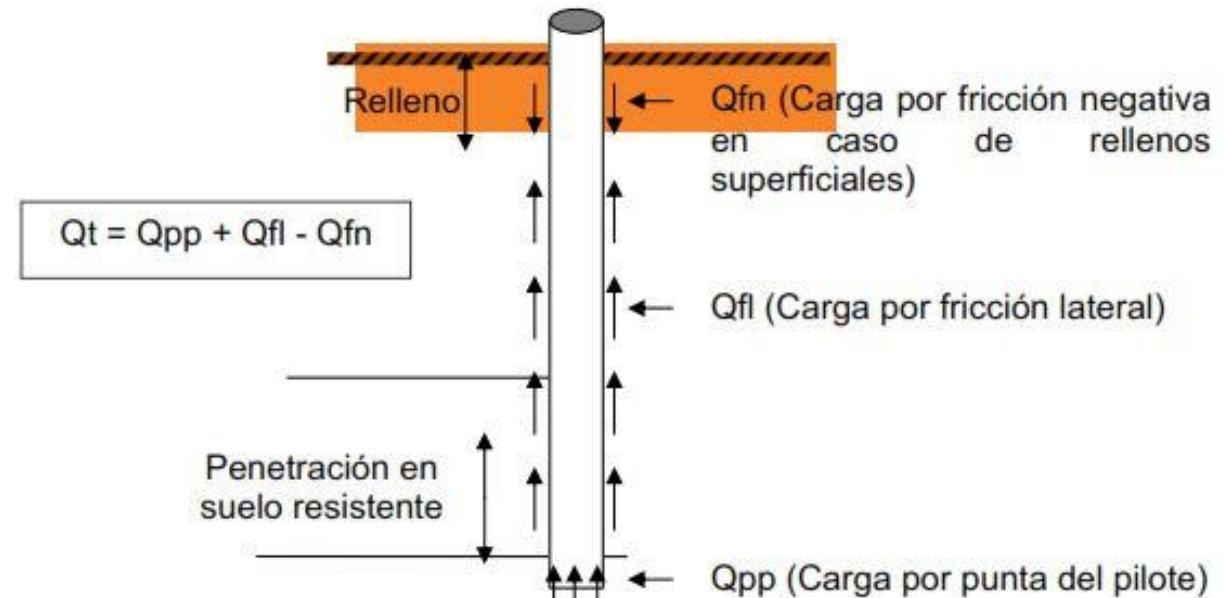

Condiciones del Subsuelo donde amerita uso de Pilotes

- ✓ PRESENCIA DE ESTRATOS SUPERFICIALES DÉBILES O MUY COMPRESIBLES.
- ✓ PROYECTOS EN LOS QUE SE GENEREN CARGAS INCLINADAS, CARGAS HORIZONTALES Y MOMENTOS FLECTORES ELEVADOS.
- ✓ EXISTENCIA DE SOCAVACIÓN.
- ✓ EXISTENCIA DE ESTRATOS CONSIDERABLES DE ARCILLAS EXPANSIVAS.
- ✓ PROYECTOS CON COLUMNAS CERCANAS A TALUDES POTENCIALMENTE INESTABLES.
- ✓ SUELOS LICUABLES (Suelos no cohesivos sumergidos a sollicitaciones cíclicas pueden perder súbitamente la resistencia al corte)
- ✓ FALLAS DE BORDE EN VIALIDAD

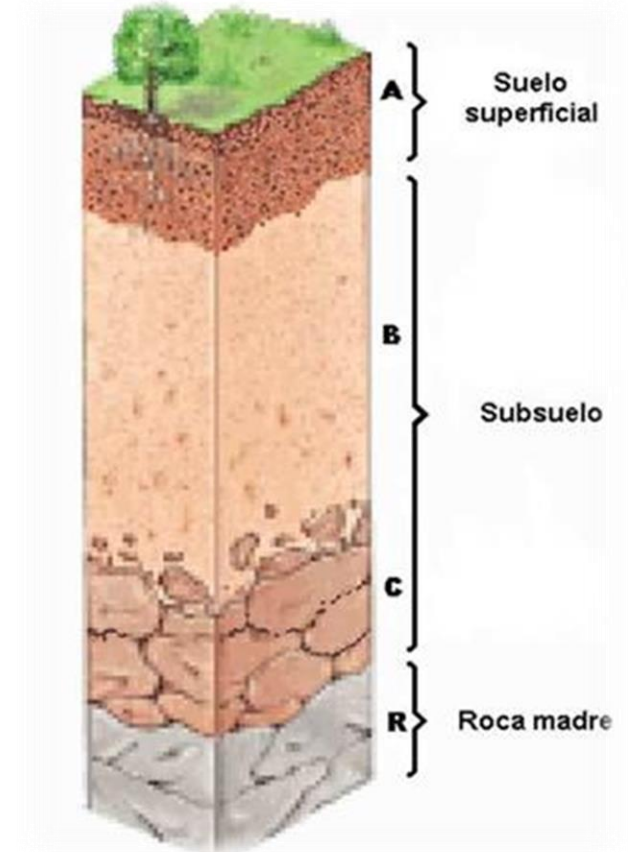

TIPOS DE PILOTES

CON DESPLAZAMIENTO

SIN DESPLAZAMIENTO

PREFABRICADOS
Φ 45 cm long. 12 y 16m

**FORRO HINCADO
VACIADO EN SITIO**
φ70 cm long. 23m

**PERFORADOS
CON ROTATIVA**
φ150cm long. 41m

**ECAVADOS CON
SONDA TIPO STRAUS**
(CIRCULAR φ 65 cm)

**EXCAVADOS CON
ALMEJAS**
PILAS OBLONGAS
MURO COLADO

MICROPILOTES
φ4" a 8"

ACERO

- ✓ TUBOS
- ✓ CAJAS
- ✓ SECCIONES H



CONCRETO

- ✓ CIRCULARES
- ✓ CUADRADOS
- ✓ TUBOS
- ✓ HEXAGONALES

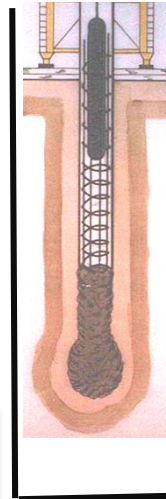

FORRO PERDIDO

FORRO RECUPERADO



CONCRETO VIBRADO

CONCRETO COMPACTADO



Distribución General de Cargas sobre pilote por cabezal

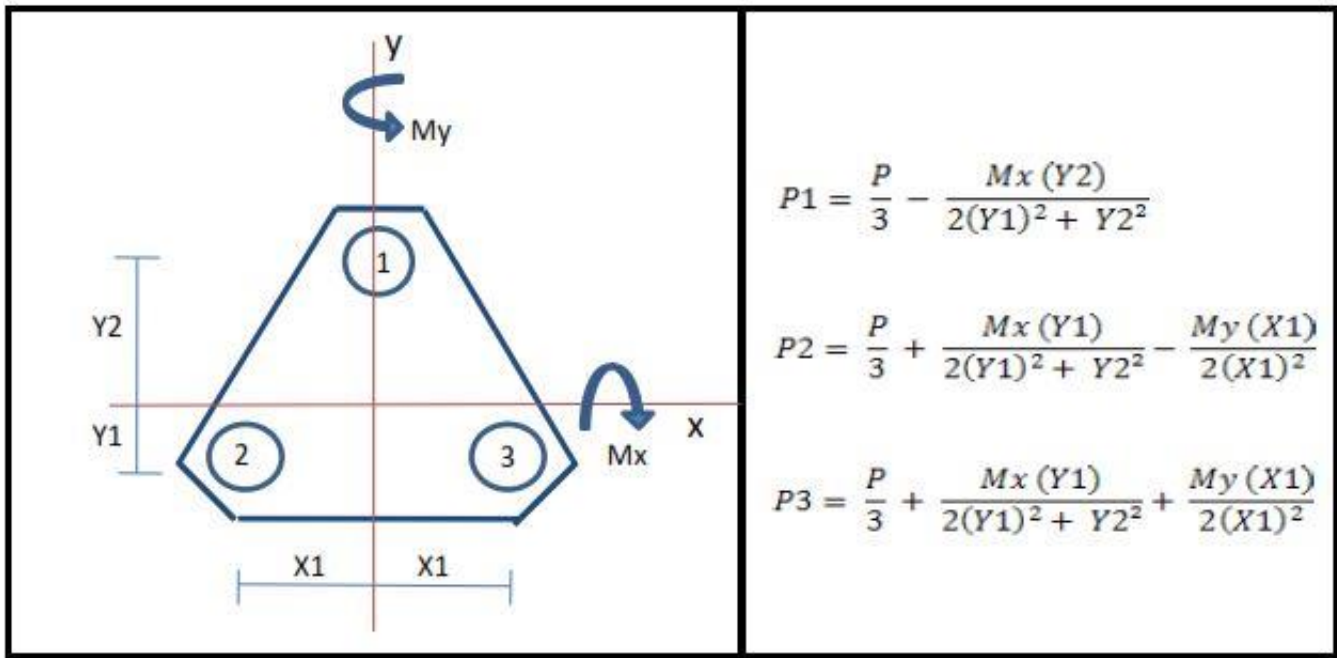

Siendo:

$P(i)$ = Carga axial en cualquier elemento "i" de un grupo

P = Carga axial total de columnas

N = Número de elementos en el grupo

M_x = Momento alrededor del eje X

M_y = Momento alrededor del eje y

x, y = Abscisa y ordenada de cada elemento en el grupo, (origen de coordenadas en el centro de gravedad del grupo de elementos).

$$P_{(i)} = \frac{P}{N} \pm \frac{M_x}{\sum y^2} y \pm \frac{M_y}{\sum x^2} x$$

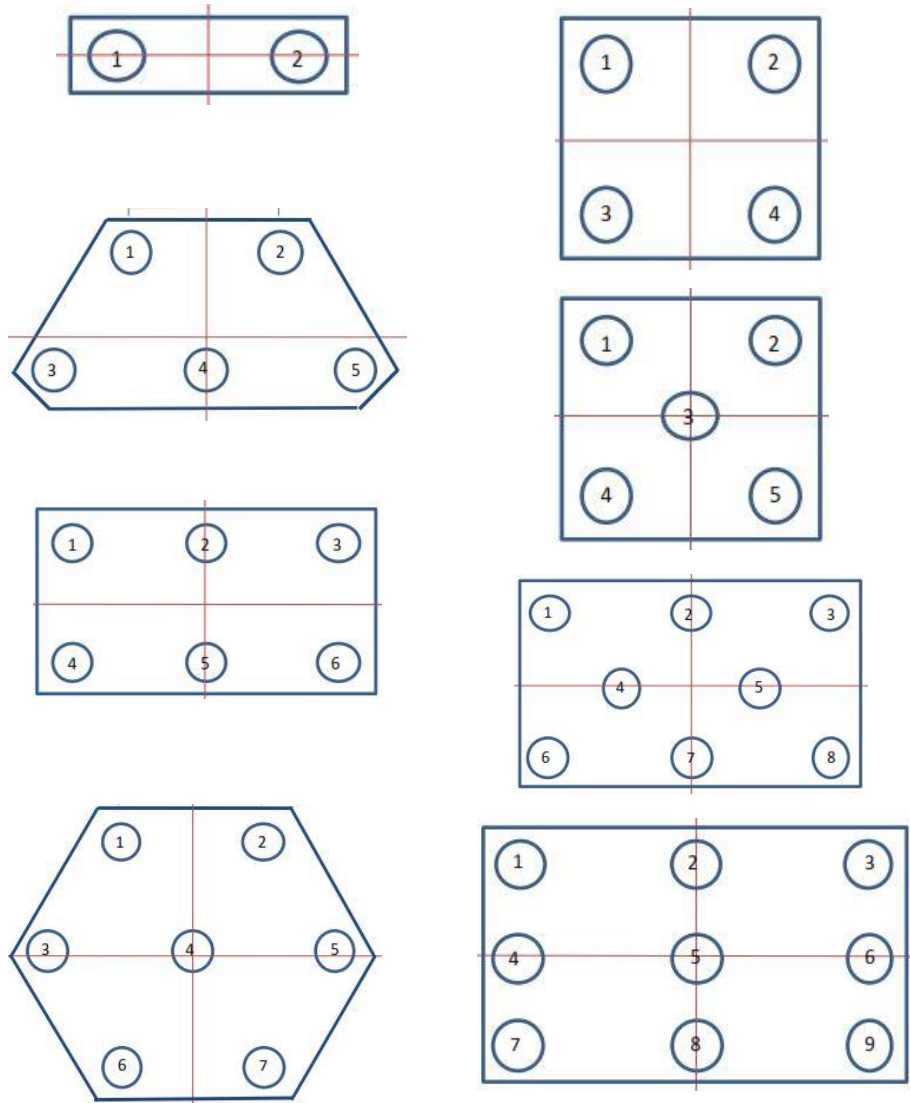

Separación mínima entre pilotes: Pilotes perforados 2 diámetro y en pilotes hincados 3 diámetro

Esquema de Medición del Pilote Rotado Perforado en Seco o Bajo Lodo

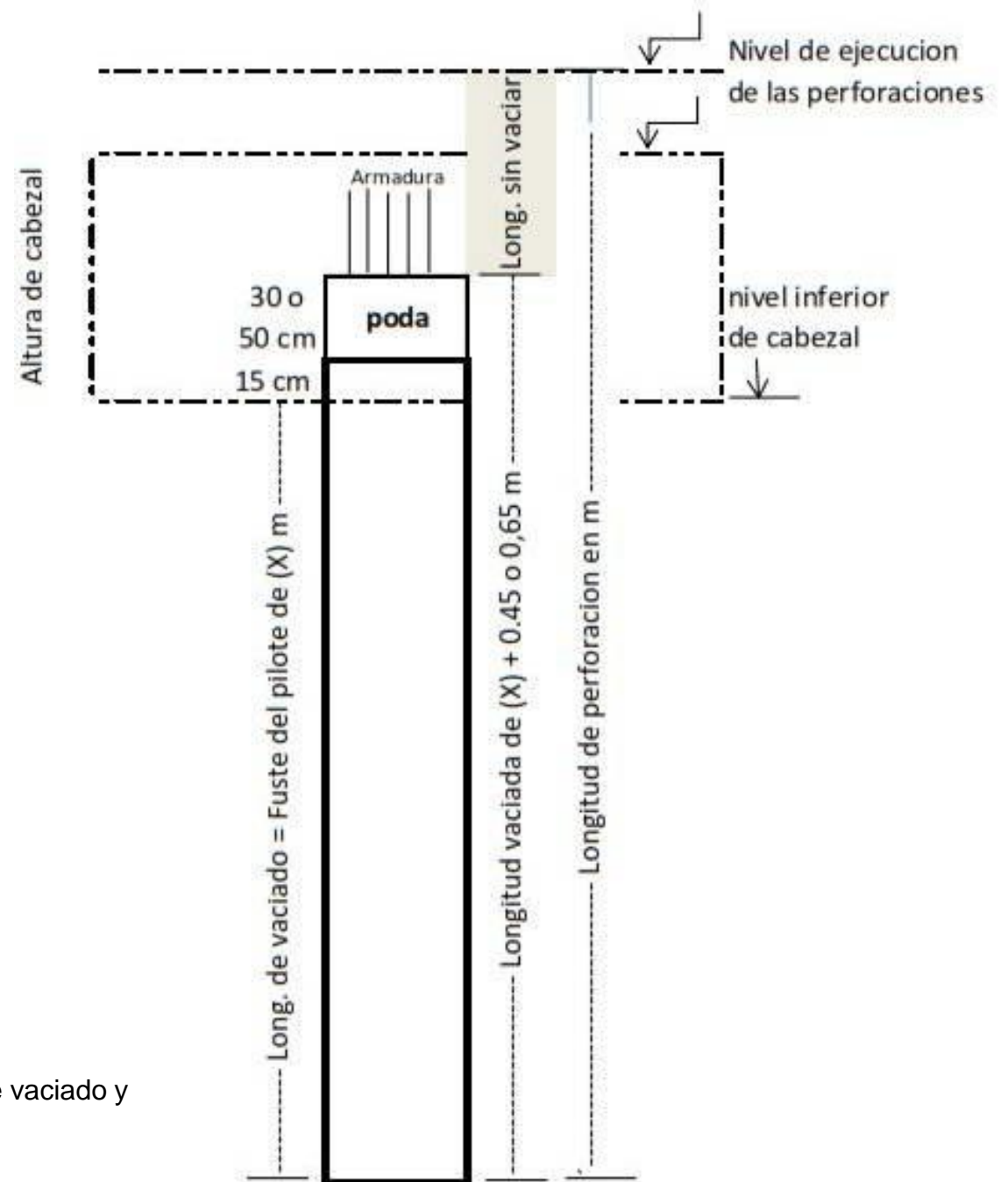

NOTA: La inspección debe suministrar plano de pilotaje al Contratista con cotas de vaciado y cota de punta de cabilla de todos los pilotes



Descripción típica de partidas para construcción de pilotes perforados

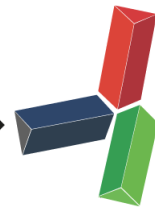

DESCRIPCION	UND	MEDICION
Perforación en suelo en seco	ML	Distancia vertical en metros, entre el nivel de ejecución (plataforma de trabajo) y el nivel final de la perforación.
Preparación y colocación del refuerzo metálico	KG	Cantidad de acero confeccionado, se cuantifica por piezas utilizadas diámetro x long x kg/m
Vaciado con tubería tremie	M3	Sobre camión de concreto premezclado.
Perforación en suelo bajo lodo bentonítico	ML	Distancia vertical en metros, entre el nivel de ejecución (plataforma de trabajo) y el nivel final de la perforación, independientemente de la profundidad del nivel freático.
Preparación, colocación y uso de lodo bentonítico	M3	Sobre camión de concreto premezclado
Uso de Cíncel o trepano	Hora	Desde que la máquina detiene el proceso de perforación hasta que se reinicia.
Transporte de maquinaria y equipos	SG	

NOTAS GENERAL: Corren por cuenta del cliente: el suministro de los materiales a pie de máquina a un ritmo constante y diurno (acero, alambre, concreto asentamiento 7 1/2", sacos de bentonita), replanteo topográfico, poda o descabezamiento de los pilotes, bote de tierra, bote de lodo bentonítico, retro excavadora diaria con su operador a disposición de Pilotes KS, la vigilancia las 24 horas días calendario, instalaciones sanitarias o baños químicos, suministro de agua para manutención del personal y preparación de lodo, plataforma de trabajo seca y estable, toma de cilindros de concreto,

PARTIDAS E32117 A E32122 PILOTES PERFORADOS CON EXTRACCION DE TIERRA, CON O SIN CAMISA DE PROTECCION.(PARTIDAS E321170050 A E321220150)
NORMA COVENIN 2000-92
PARTE 2A.EDIFICACIONES

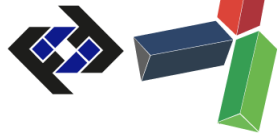

PLANO DE PILOTAJE

Planilla de S.P.T. de la obra

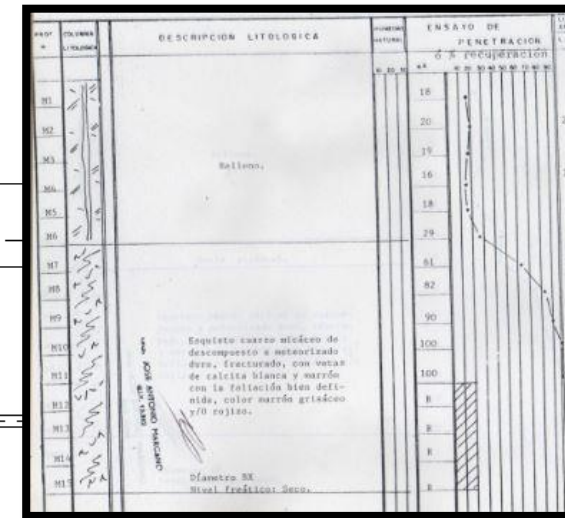

Ø= Diámetro del Pilote
R= Espesor de Relleno
LP= Longitud Perforada del Pilote
NE= Nivel de excavación

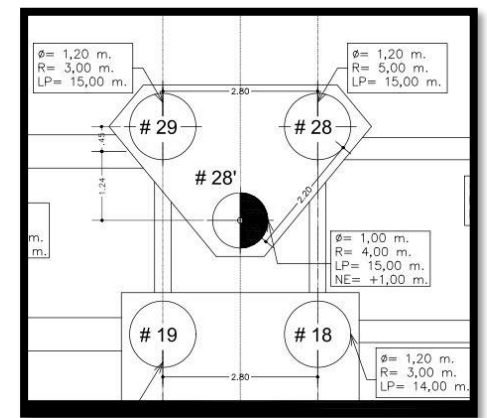
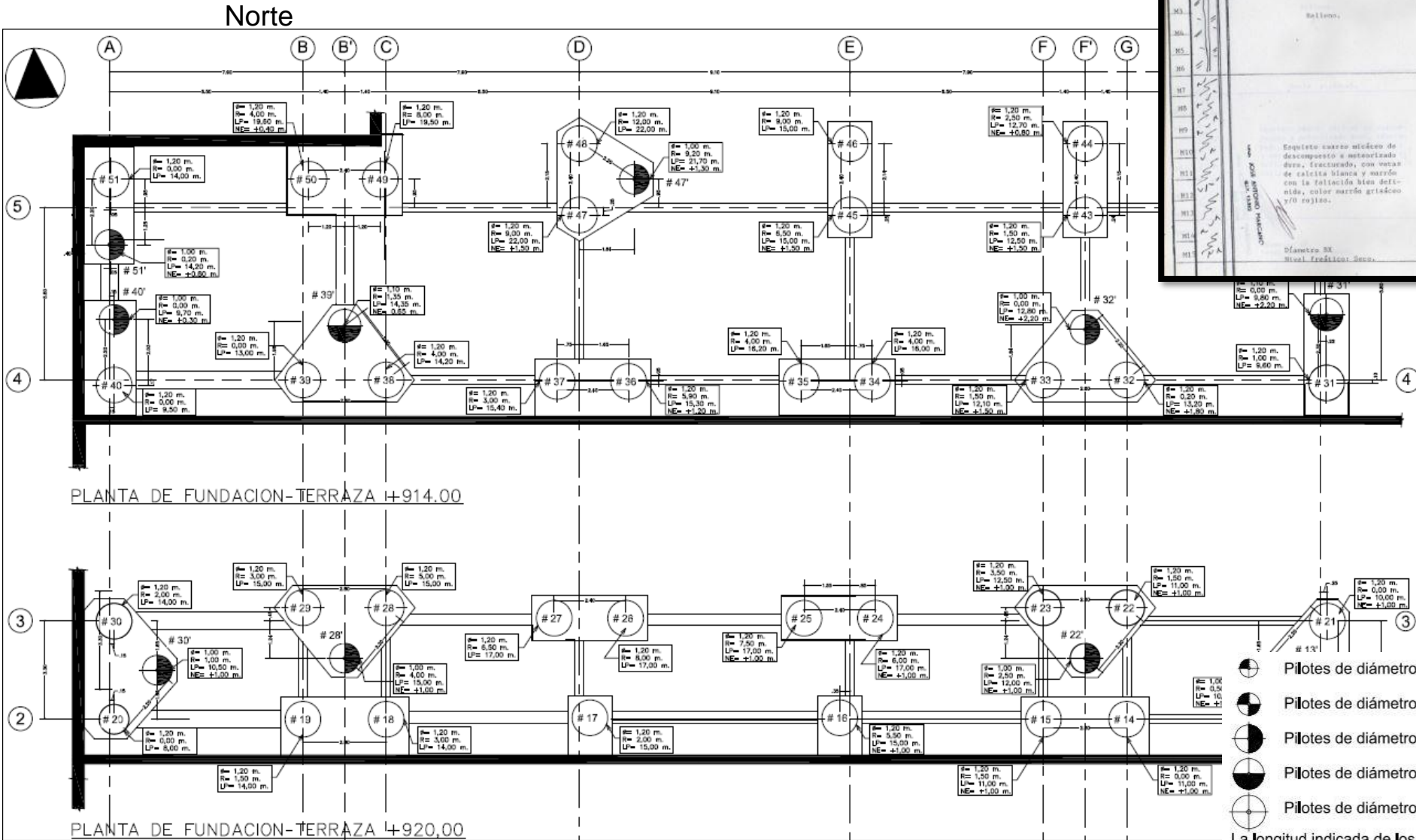

- Pilotes de diámetro 0,65 m., armados con 7 Ø 1" longitudinal, y, Ø $\frac{3}{8}$ " @ 0,20 m.
- Pilotes de diámetro 0,80 m., armados con 10 Ø 1" longitudinal, y, Ø $\frac{3}{8}$ " @ 0,20 m.
- Pilotes de diámetro 1,00 m., armados con 15 Ø 1" longitudinal, y, Ø $\frac{3}{8}$ " @ 0,20 m.
- Pilotes de diámetro 1,10 m., armados con 19 Ø 1" longitudinal, y, Ø $\frac{3}{8}$ " @ 0,20 m.
- Pilotes de diámetro 1,20 m., armados con 22 Ø 1" longitudinal, y, Ø $\frac{3}{8}$ " @ 0,20 m.

La longitud indicada de los pilotes está medida desde el nivel de las plataformas 914,00; 920,00 y 926,50

DETALLE DE ARMADURA

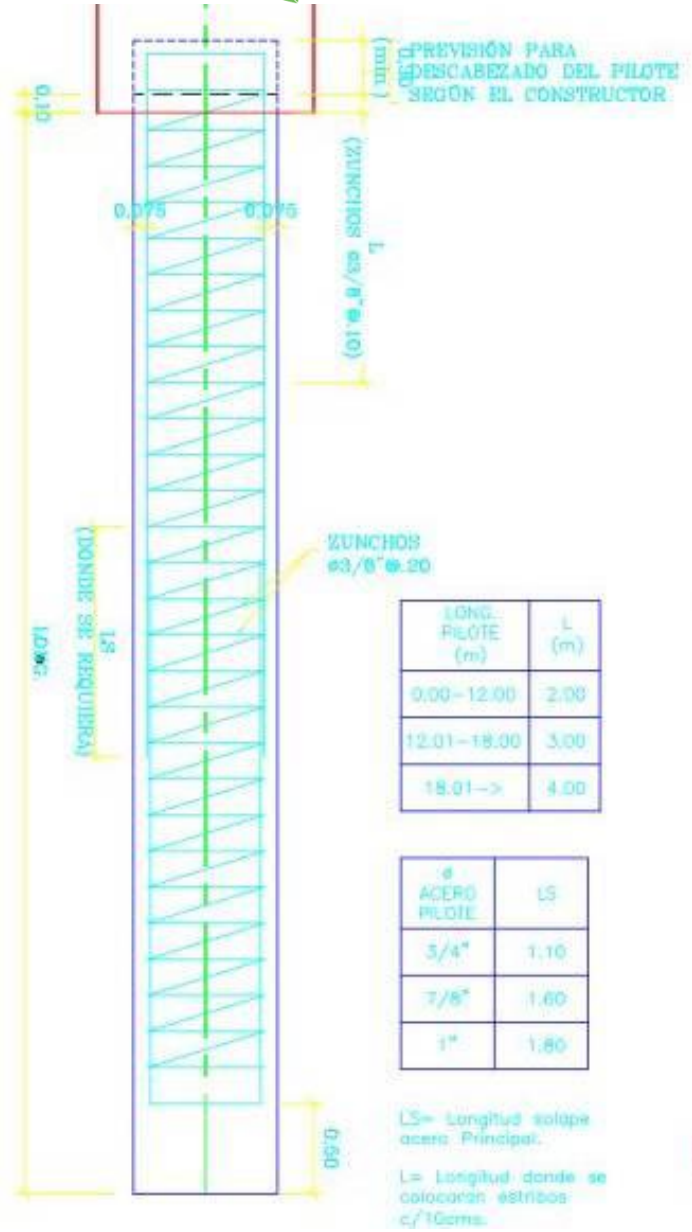

NOTAS

Cabilla longitudinal y transversal: Separación mínima cara a cara >10cm , puede ser de 8 cm usando agregado grueso \leq diámetro 2cm o armar longitudinal las cabillas en dos capas en forma radial cumpliendo sep. \geq 2 diam. cab y sep. \geq 1.50 diámetro agregado grueso.

Cuantía mínima de acero \geq 0.5% de la sección gruesa del pilote

Norma PrEN 1536:1996,
 Execution of special geotechnical work bored piles.

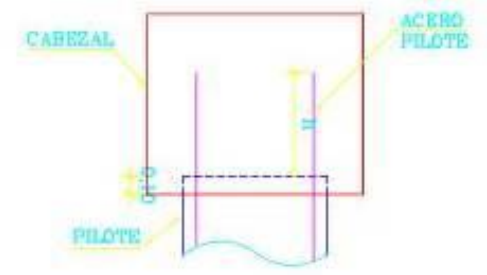

ϕ ACERO PILOTE	fi
3/4"	45
7/8"	50
1"	60

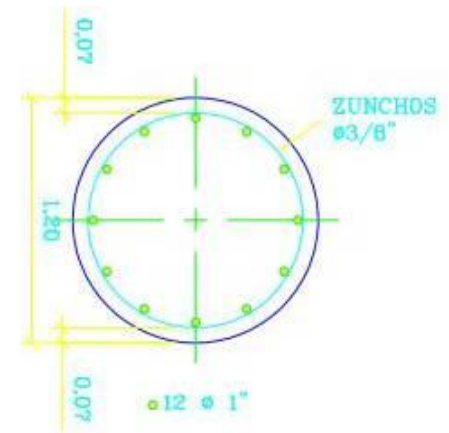

PILOTE $\phi 1.20$
 S/E

DETALLE ACERO DE ANCLAJE PILOTE - CABEZAL

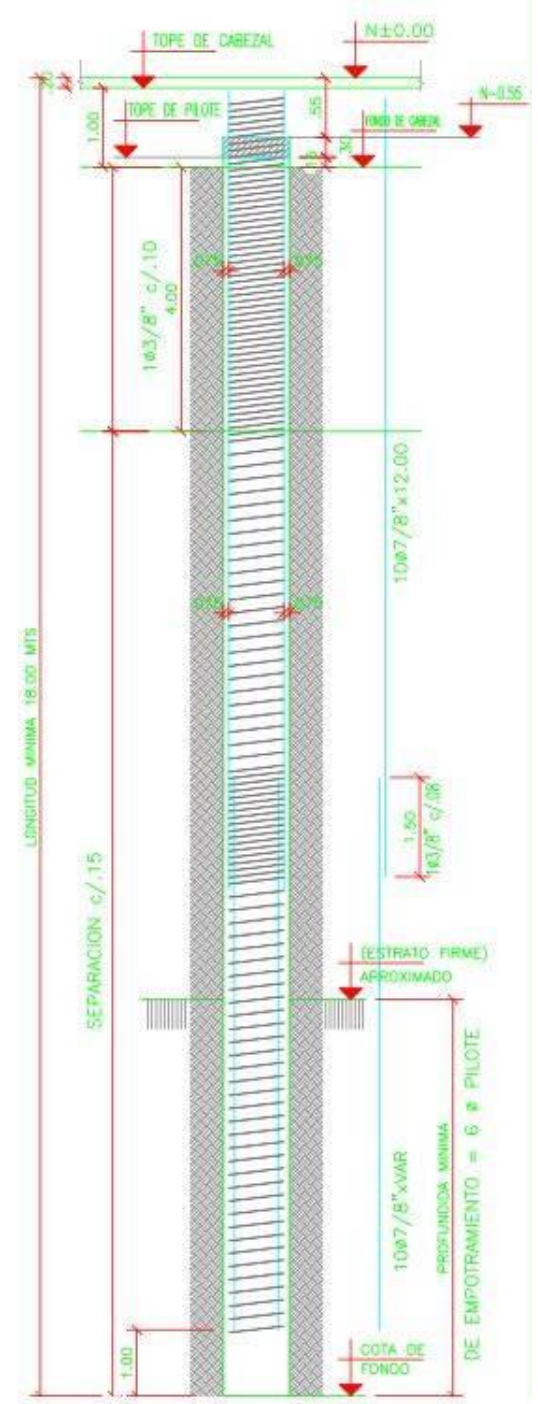



PILOTES **KS**
GEO CONSTRUCCIONES Y MAQUINARIAS C.A

Maquinas de Perforación Disponibles



*Nuestras instalaciones físicas:
Deposito 8000mt²-Santa Teresa del Tuy*



Nuestras instalaciones físicas: Deposito 1500mt². Urb. La Florida



COREDRILL con Taladros Hilti
hasta 15" de diámetro y long. 85 cm



PERSONAL CALIFICADO



HERRAMIENTAS PARA AVANCE DE LA PERFORACIÓN

Cinzel o Trepano



Herramientas de Perforación para atravesar rocas (maq. Sistema hidráulico)

Mechas con dientes con punta de widia



Casambas Perforación con dientes, punta widia para atravesar rocas (maq. sistema mecánico)



Herramientas de Perforación baldes (casambas) para suelo con diversos diámetros 0.60 a 1.50 m





PILOTES **KS**

GEO CONSTRUCCIONES Y MAQUINARIAS C.A

ACOPLE DEL SISTEMA DE PULL DOWN

Similar A Maq. Hidraulica Crante Attachment



Detalle gatos hidráulicos del Sistema del pull down

Trabajando el sistema de pull down
Durante el avance de la perforación en
Estratos duros con apoyo del
trepano

SISTEMA DE PULL DOWN EN MAQ. HIDRAULICA S/ORUGA



Gatos
Hidráulicos

PERFORACION EN SECO
ROTACION MECANICA
MAQ. TIPO CALWED S/CAMION



*Diámetros de perforación 0.30 a 1.20 m y con ensanchador hasta 1.40 m en función del tipo de sub suelo

*Profundidad 28 m con uso de extensión prolonga hasta 33 m en función del tipo de sub suelo.

PERFORACION EN SECO
ROTACION HIDRAULICA
MAQ. TORQUE 15 TONxM S/ORUGA



*Diámetros de perforación 0.30 a 1.50 m

*Profundidad 36 m con uso de extensión prolonga hasta 41 m en función del tipo de sub suelo.

**PARAMETROS DE LOS ENSAYOS
DEL LODO BENTONITICO**

Propiedad	Unid	Preparación de Mezcla	Fondo de Perforación	Antes de Vaciado
Densidad	Gr/cm ³	< 1,10	No limita	No limita
	Lb/Pie ³	< 68,67	No limita	No limita
Viscosidad Seg/0,95 Lts	Seg	32 a 45	34 a 50	1 Vez/día
PH		7 a 11	7 a 12	1 Vez/día
Max contenido de Arena	%	-	< 6	1 Vez/día cada Pilote antes del Vaciado

NOTAS:
POR PROCESO CONSTRUCTIVO EL DIAMETRO MINIMO DE PERFORACION BAJO LODO ES DE 65CM,
DOSIFICACION DE BENTONITA: MARCA BAROID DE HALLIBURTON EN SACO DE 50 LBS, DOSIFICAR 1 SACO X 1 M3 DE AGUA

PROCESOS DE ENSAYOS DURANTE LA PERFORACION:
FRECUENCIA MAXIMA DE ENSAYOS DURANTE LA PERFORACION TOMANDO MUESTRAS DEL PREFERIBLEMENTE DEL FONDO DE LA PERFORACION POR MEDIO DEL BALDE O SUCCION DE BOMBA
PARAMETROS:
VISCOSIDAD 6 VECES C/4 m Y PH 6 VECES
RESULTADOS COMPARAR CON PARAMETROS FONDO DE PERFORACION

ALMACENAMIENTO

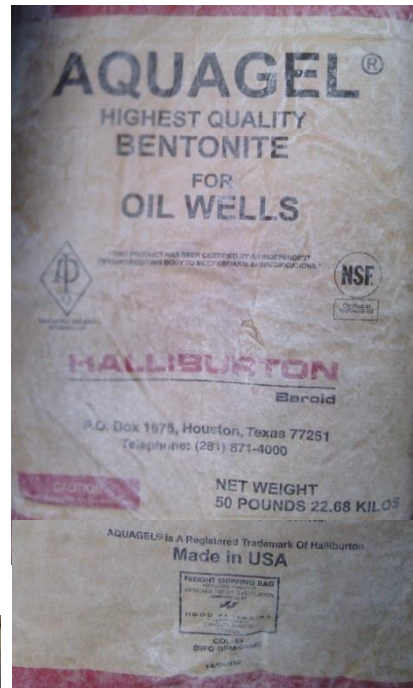

MARCAS DE BENTONITA EN EL MERCADO

Bentonite

- *Bentonita* es nombrada así por el depósito encontrado cerca de Fort Benton, Wyoming.
- El término *bentonita* se define originalmente como la arcilla producida en sitio debido a la alteración de la ceniza volcánica a convertirse en una montmorillonite.
- El término *Bentonita* es usada ahora para cualquier arcilla cuyas propiedades físicas están dominadas por la presencia de la smectite

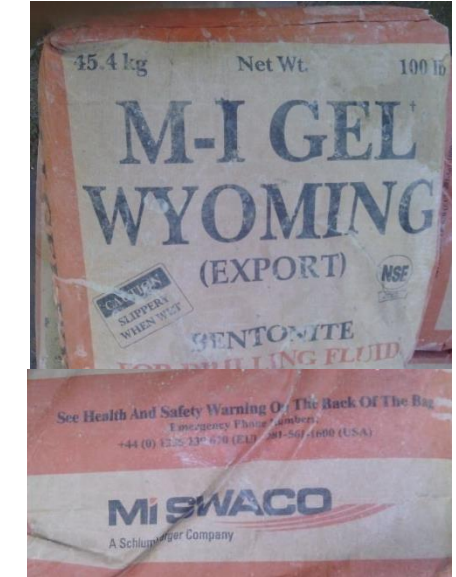
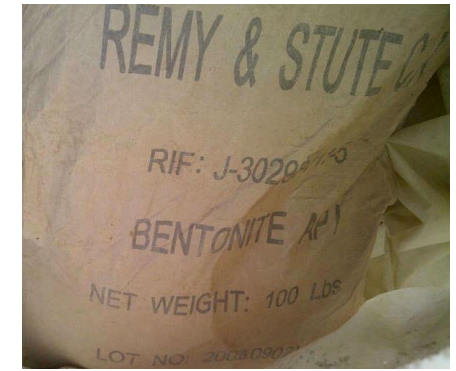

Mecanismo de la Filtración

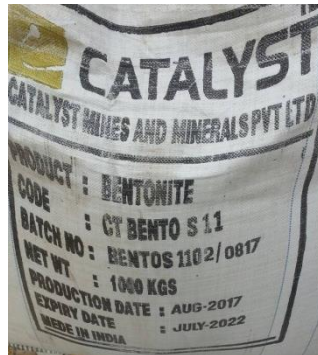
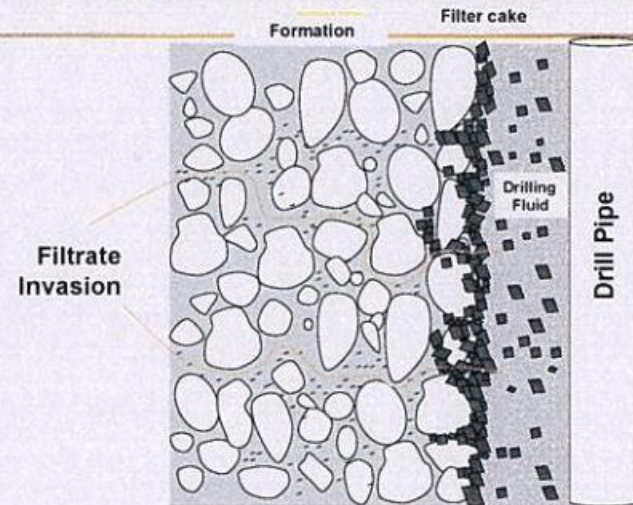

ENSAYOS DEL LODO BENTONITICO



MEDIR % DE CONTENIDO DE ARENA

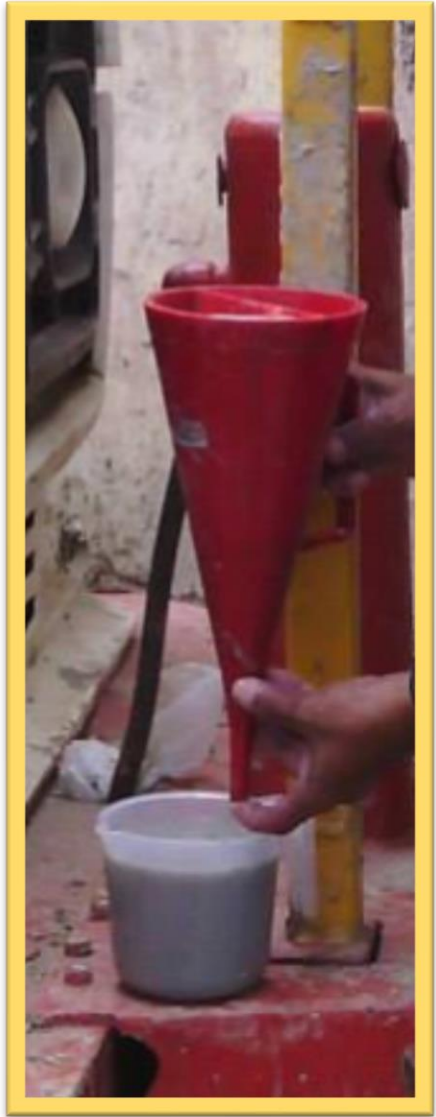

MEDIR VISCOSIDAD PORSEGUNDOS CON EL CONO DE MARSH

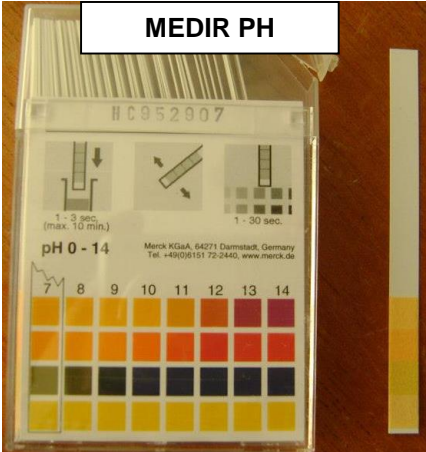

MEDIR PH

MEDIR DUREZA DEL AGUA

ENSAYO COMPLEMENTARIO OPCIONAL, MEDIR PH, SE PUEDE CONTRARRESTAR Y CONTROLAR VALORES DE PH CON ADITIVOS, OPERACIÓN MUY DELICADA, CONTROLANDO LA DUREZA DEL AGUA CON ENSAYOS

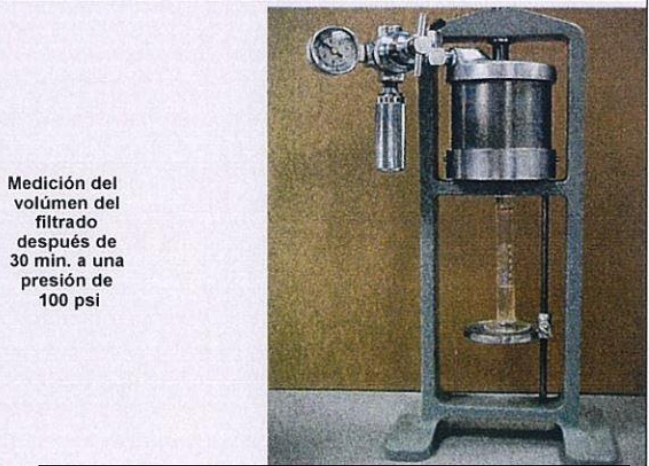

Medición del volúmen del filtrado después de 30 min. a una presión de 100 psi

CAMARA DE VOLUMEN DETERMINADO



BALANZA MEDIR DENSIDAD

ENSAYOS COMPLEMENTARIOS:

- * MEDIR DENSIDAD CON BALANZA O HIDROMETRO.
- MEDIR CONTENIDO DE AGUA LIBRE CON PRUEBA DE FILTRO 1" EN UNA CAMARA DE VOLUMEN DETERMINADO.
- * MEDIR PH DEL LODO NUEVO Y EN PERFORACION

EQUIPOS PARA USO DE LODO BENTONITICO PARA PILOTES Y MURO COLCADO



Balanza medidor de densidad



Medir % contenido de arena



Tanques



Tubería rígida



Recuperación de lodo bentonitico con bombas



Medir viscosidad

Ensayos del lodo



Mezcladoras cap. 1 y 2 m3 preparación de lodo bentonitico



Tanques y plantas eléctricas

PERFORACION BAJO LODO BENTONITICO

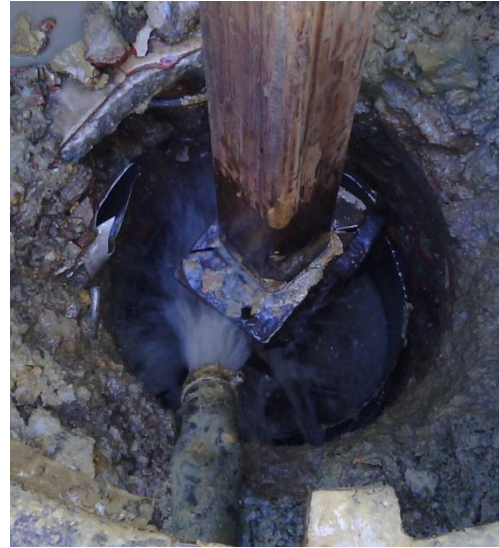

*Diámetros de perforación 0.65 a 1.50 m, profundidad 33 m a 41 m en función del tipo de maquina rotativa.

CONFECCION DE LA ARMADURA DE REFUERZO DEL PILOTE



Rigidizadores y armadura longitudinal morocha
evita cangrejas sep min 10 cm

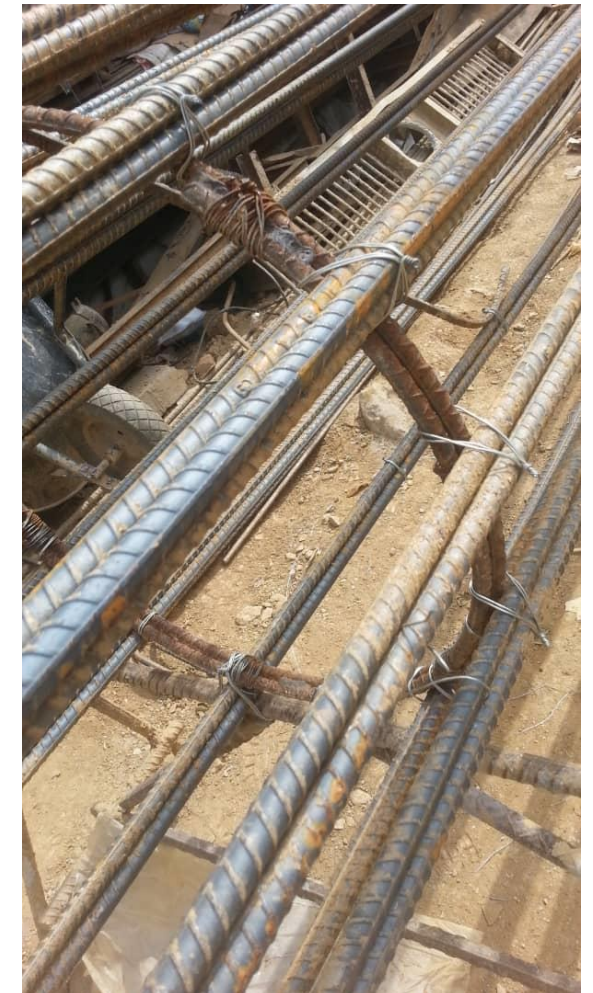
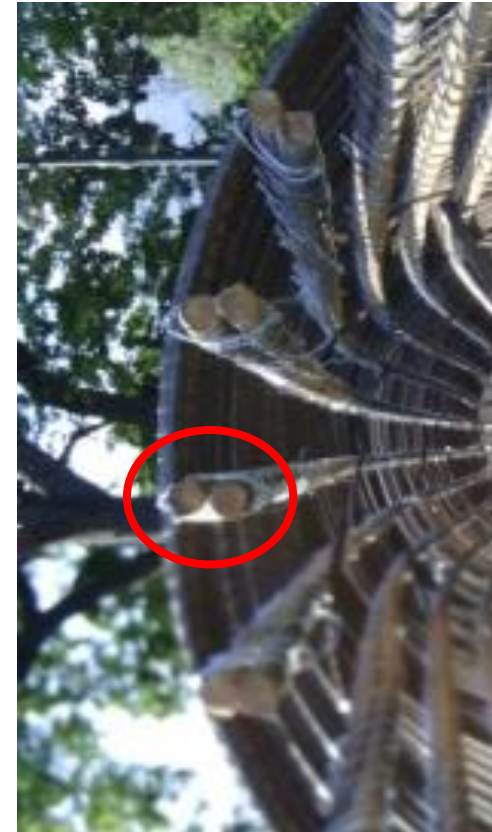
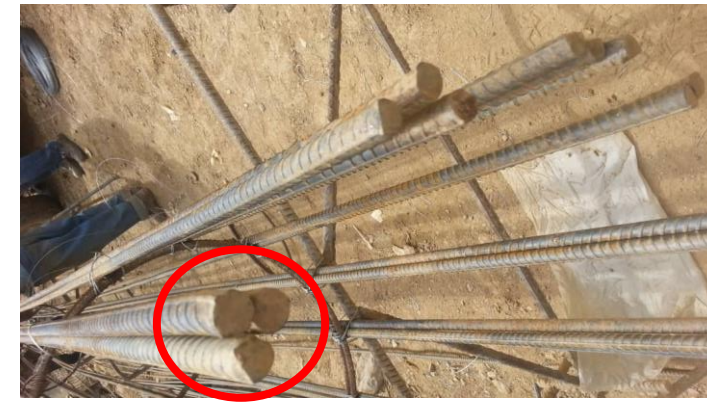
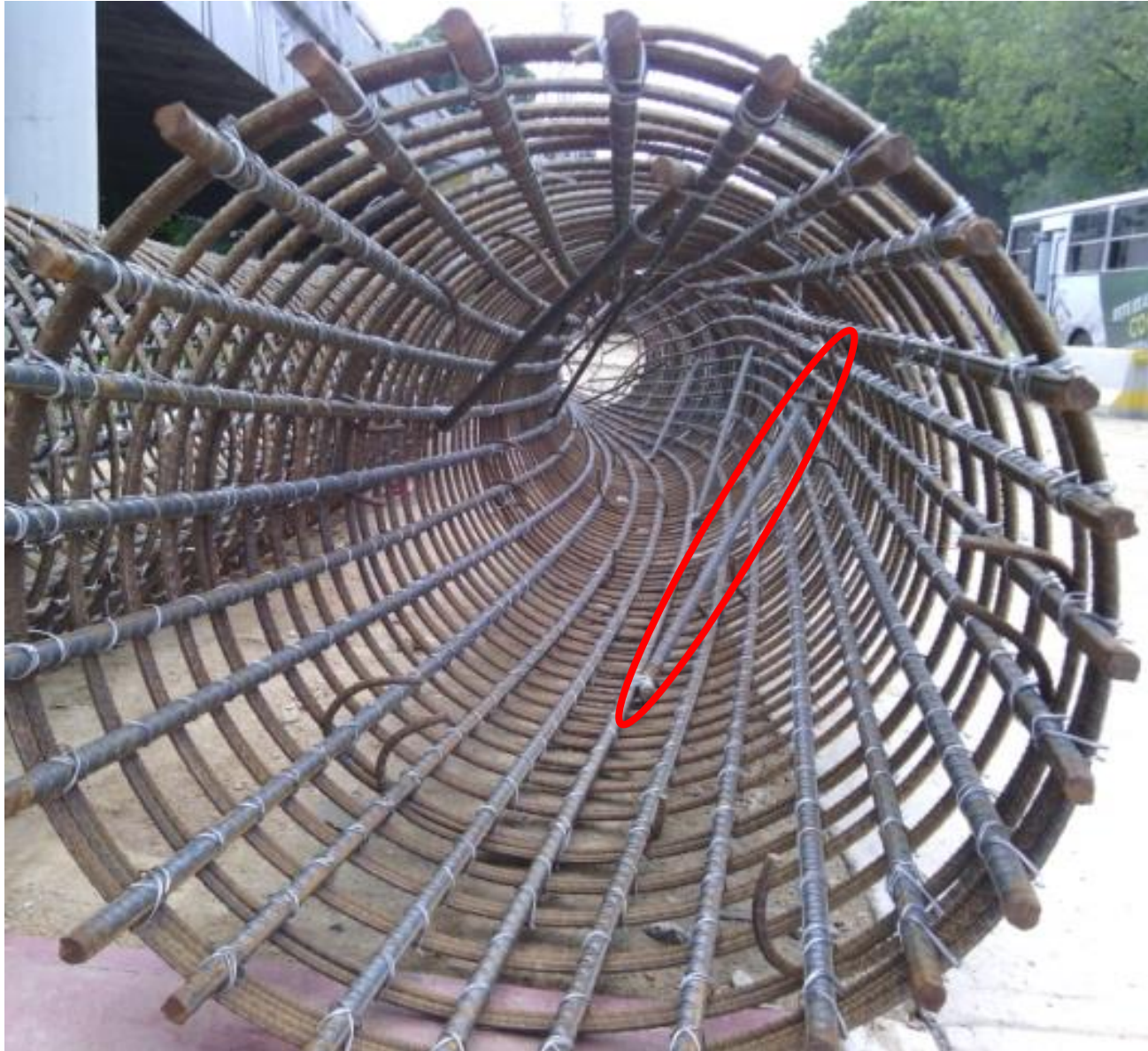

MANIOBRA , IZADO Y TRASLADO DE LA ARMADURA CONFECCIONADA



Eslingas alma de acero
Carga de trabajo



Pulgadas in	Milímetros mm	Kg.	Kg.	Kg.
1/2	12.70	1997	1453	3994
5/8	15.90	3087	2270	6173
3/4	19.05	4448	3268	8806
7/8	22.23	5992	4357	11801
1	25.40	7716	5719	15433



COLOCACION DE ARMADURA DE REFUERZO DEL PILOTE



PROCESO DE VACIADO

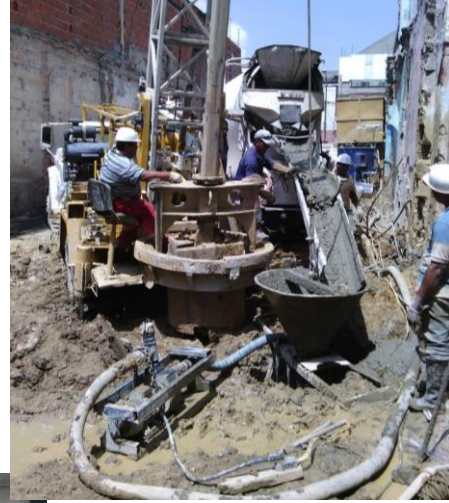

Tubería tremie tapada 2,5 h esperando concreto, asentamiento 7 1/2"

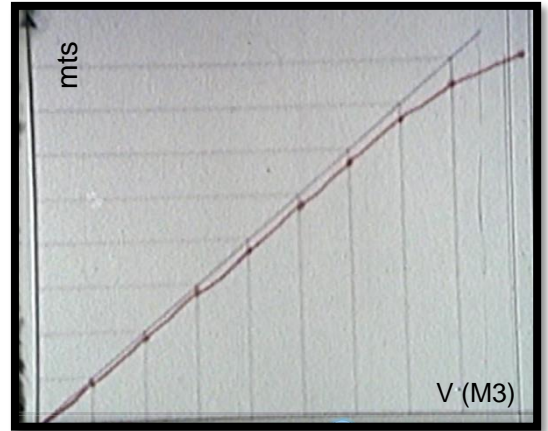

Datos generales del pilote

Diámetro del pilote: 1.10 m
 Longitud del pilote: 21.00 m 7.00
 Area del pilote: 0.95 m²
 Volúmen teórico pilote: 19.95 m³

N° de camiones	Volumen c/camión	Volumen vaciado	Altura medida
1	4	7.00	-14.00
1	7	7.00	-7.00
1	7	7.00	-3.00
1	3	3.00	-0.80
1	0	0.00	0.00
5		24.00	

CONTROL EN AVANCE DE VACIADO

Obra:

Fecha: 30-07-18

Long. Perforada 21
 Cota de vaciado con poda 0
 Long. vaciada 21
 Rcc Kg/cm²: 300 Asentamiento 7"

Datos teóricos		Datos de Campo	
Altura	Volumen	Altura	Volumen
21.00	0.00	21.00	0.00
20.00	0.95	14.00	7.00
19.00	1.90	7.00	14.00
18.00	2.85	3.00	21.00
17.00	3.80	0.80	24.00
16.00	4.75		
15.00	5.70		
14.00	6.65		
13.00	7.60		
12.00	8.55		
11.00	9.50		
10.00	10.45		
9.00	11.40		
8.00	12.35		
7.00	13.30		
6.00	14.25		
5.00	15.20		
4.00	16.15		
3.00	17.10		
2.00	18.05		
1.00	19.00		

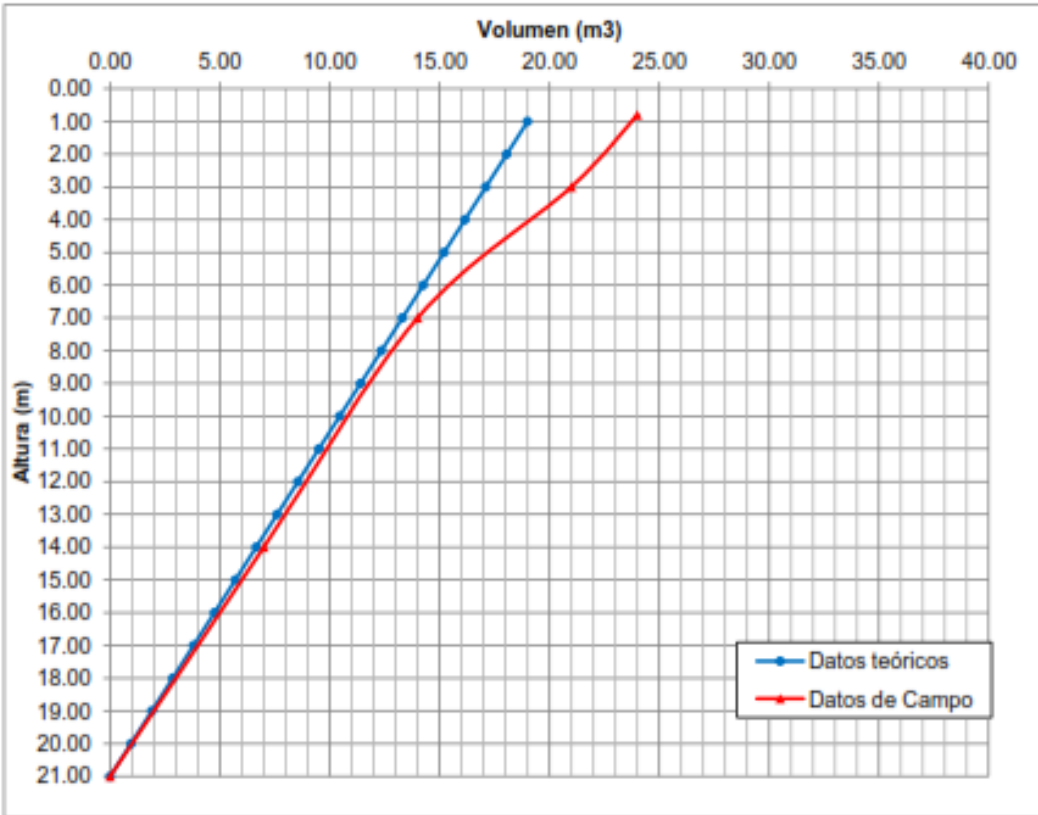

**PILOTE
RECIENTE
HECHO**

**LIMPIEZA
PRELIMINAR**

CONCRETO NO COMPACTADO A SER
ELIMINADO ANTES DE PROCEDER A LA PODA.

**FORMA INCORRECTA
DE PODAR**

SE RAJA LA PARTE SUPERIOR DEL PILOTE.

**FORMA CORRECTA
DE PODAR**

SE COLOCAN LOS CINCELES EN SENTIDO
HORIZONTAL DIRIGIENDO LOS LIGERAMEN
HACIA ARRIBA QUITANDO CAPAS DE 5 A
10cms. APROX. DESDE LA PERIFERIA AL CENTE
DEL PILOTE- DEJANDO LA CABEZA DEL PILOT
CONVEXA.

**PILOTE
TERMINADO**

PODA DE PILOTE

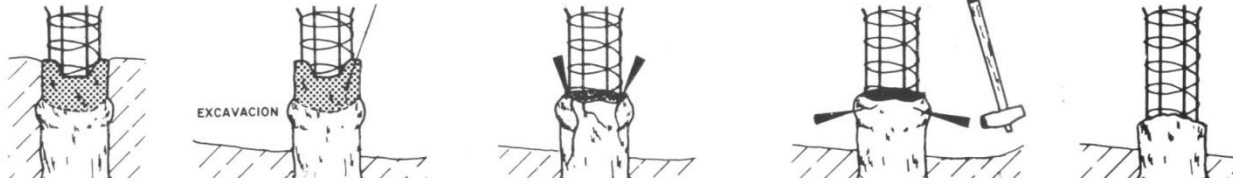

Uso de retroexcavadora para carga y jumbo para acarreo de material proveniente de la perforación con lodo



**CANTOS RODADOS, PEÑONES O OBSTÁCULOS QUE
DIFICULTAN AVANCE DE PERFORACIÓN (Proceso para retirarlos)**



PRUEBAS DE INTEGRIDAD DEL PILOTE PRUEBAS ESTATICAS

Aplicación de carga a Compresión ASTM D-1143 y D-3966
, Tracción ASTM D-3689-90 y Horizontal

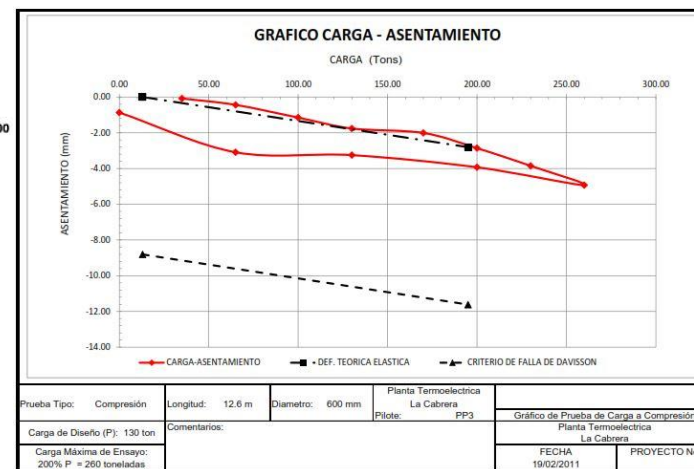
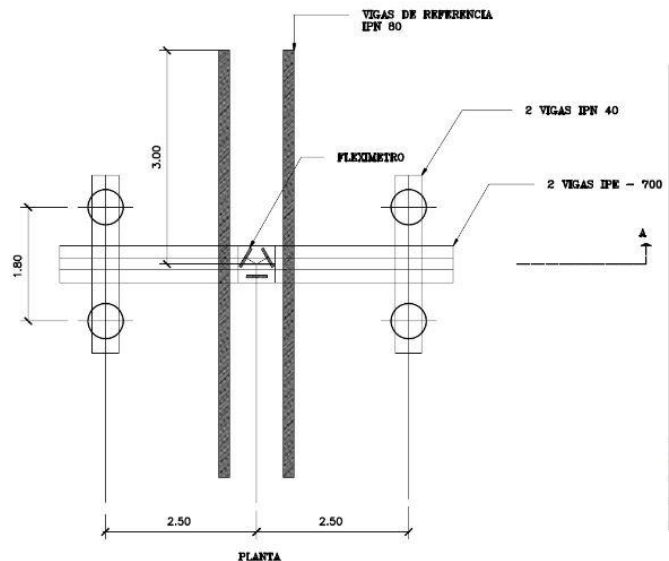
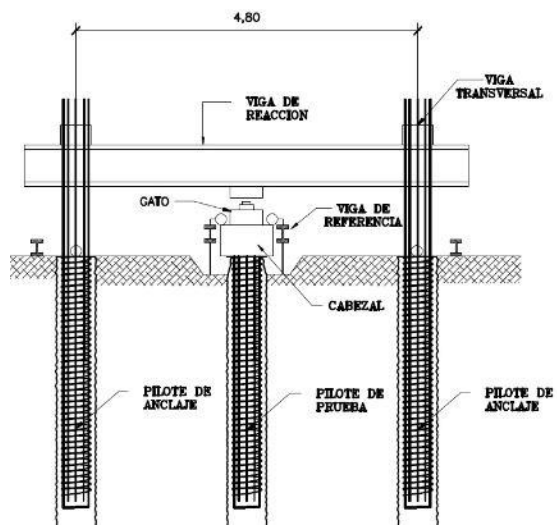

PRUEBAS DE INTEGRIDAD DEL PILOTE PRUEBA DINAMICA

PILE INTEGRITY TESTING (PIT) ASTM D5882-00

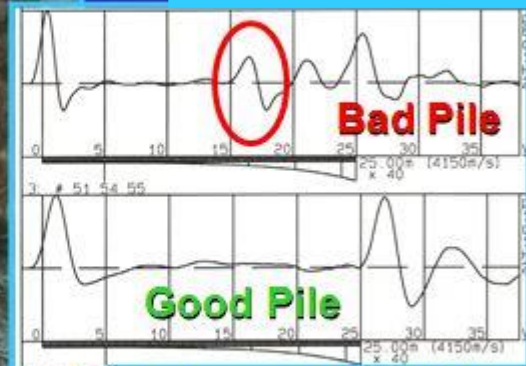
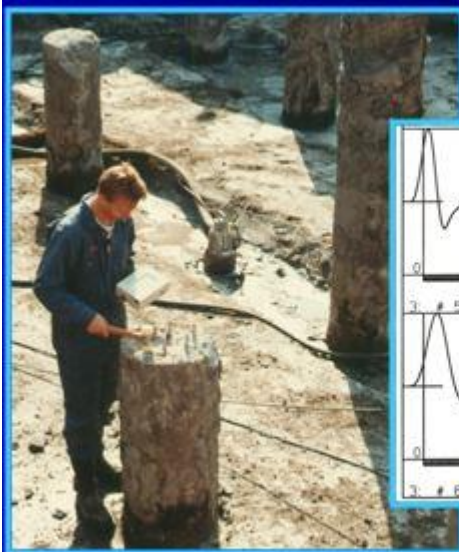
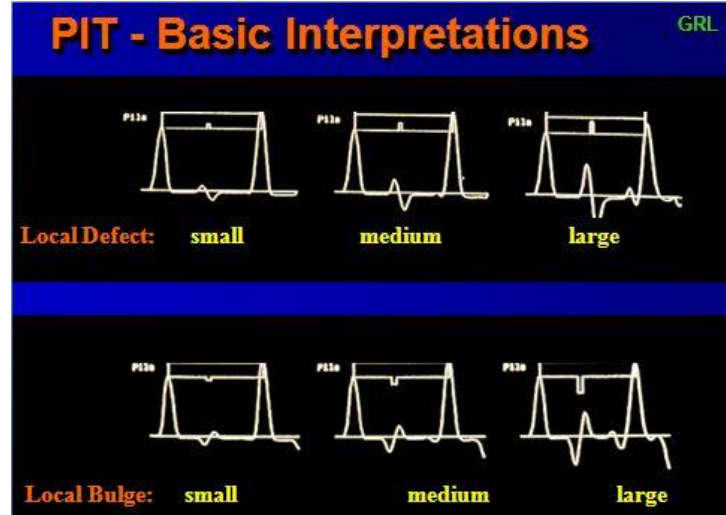
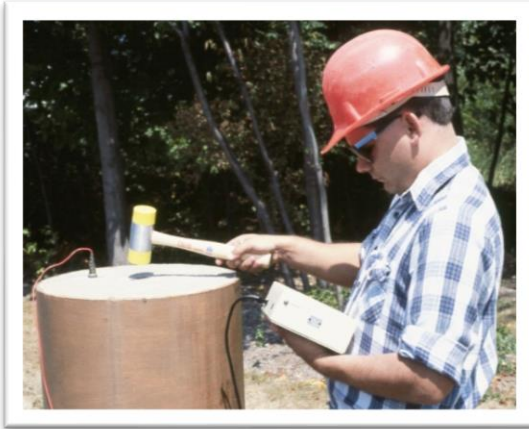

800 mm drilled shafts
L = 25 m (L/D = 31)

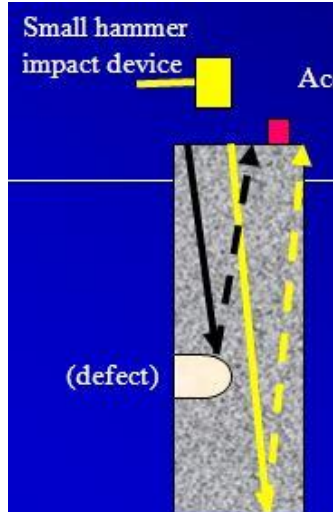

DESCRIPCION: Ensayo que visa principalmente determinar la variación a lo largo de la profundidad de las características del concreto del pilote. Consiste en usar un acelerómetro de alta sensibilidad en la cabeza del pilote bajo prueba y en la aplicación de golpes con un martillo de mano instrumentado. Golpes generan una onda de tensión que recorre el pilote y sufre reflexiones al encontrar cualquier variación en la aceleración con el tiempo con las características del material diferente (área de sección, peso específico, o modulo de elasticidad factores asociados a imperfecciones o defectos)

PRUEBAS DE INTEGRIDAD DEL PILOTE PRUEBA DINAMICA

CROSS HOLE SONIC LOGGING (CSL) Norma ASTM 6760-02

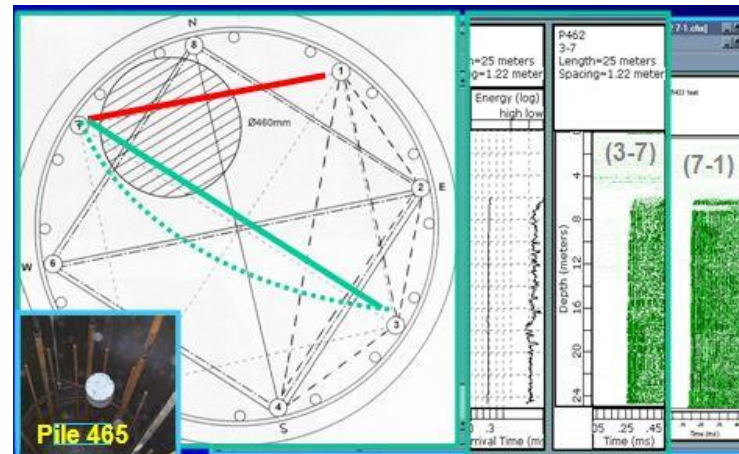
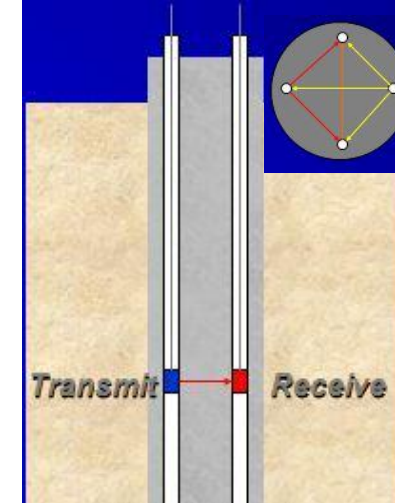
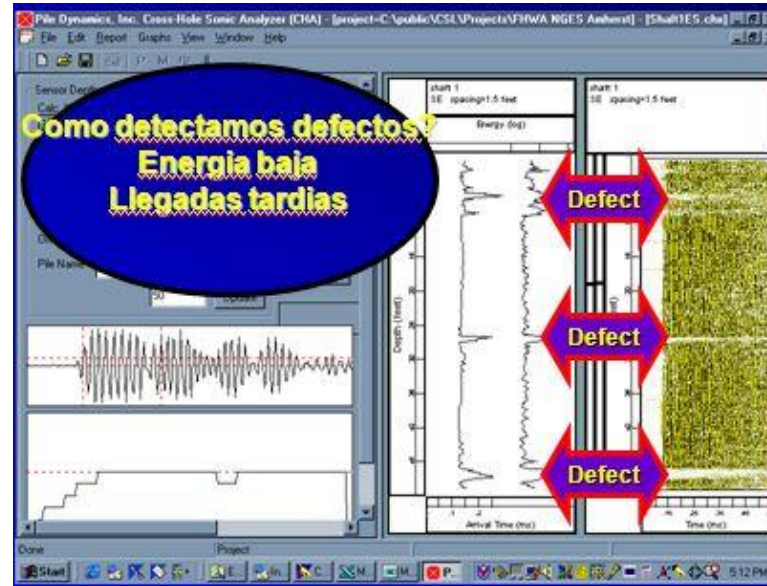

DESCRIPCION: Este método permite identificar zonas de debilidad o deterioro del concreto a lo largo del pilote, utiliza pulsos ultrasónicos con una frecuencia entre 50 a 60 KHz para medir el tiempo de transito de dicho pulso a raves del pilote de concreto. Una sonda transmisora y una receptora de ondas ultrasónicas son bajadas en tuberías (metálico o PVC sch 40 de d=2") al interior del pilote.

Proceso de construcción de pilote con perforadora rotativa



DIAGRAMA BASICO DE CONTROL DE OBRA



PILOTES **KS**

GEO CONSTRUCCIONES Y MAQUINARIAS C.A

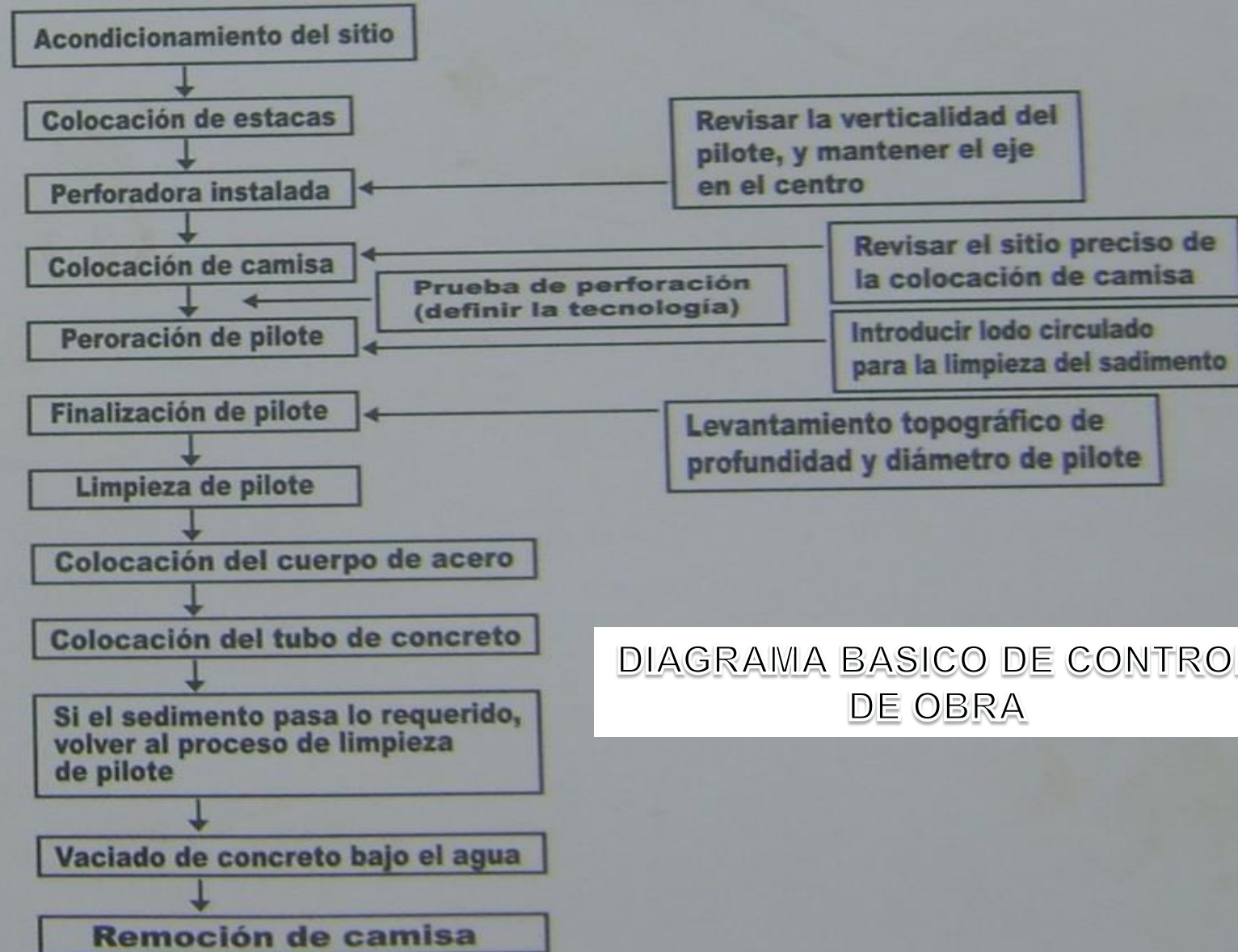
EUROPEAN STANDARD
NORME EUROPÉENNE
EUROPÄISCHE NORM

FINAL DRAFT
EN 1536 : 1998

November 1998

ICS 93.020

Descriptors: soil, foundation, bored pile, boring, definition, material, design, execution, reinforcement, concreting, inspection, test

English version

Execution of special geotechnical work - Bored piles

Exécution des travaux géotechniques spéciaux -
Pieux forés

Ausführung spezieller geotechnischer Arbeiten
(Spezialtiefbau) - Bohrpfähle

ALGUNOS DE NUESTROS CLIENTES Y EMPRESAS RELACIONADAS EN PROYECTOS
EJECUTADOS POR PILOTES KS



RELACION DE OBRAS EJEUTADAS POR AÑO
CON CARGA ACTUAL DE TRABAJO OCT/ 18

PILOTES PERFORADOS

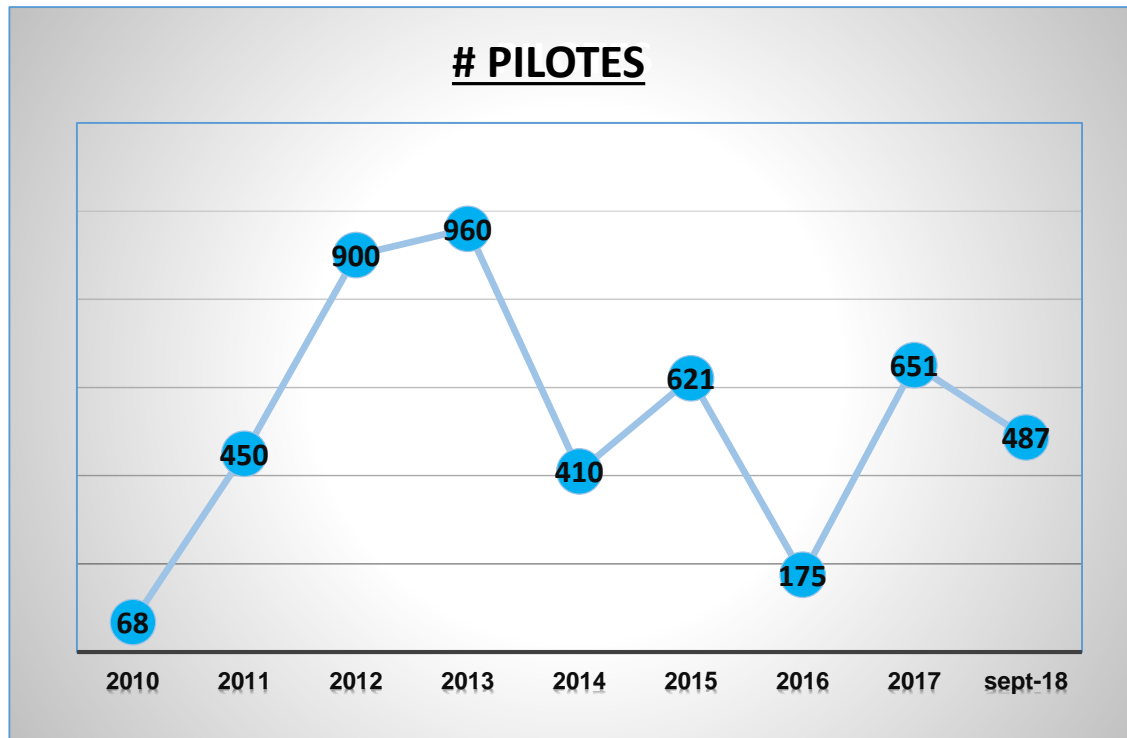

2017 Incluye 319 Micropilotes en 4908 MI
Oct-2018 Incluye 178 Micropilotes en 2022 MI

M3 CONCRETO VACIADO DE PILOTES

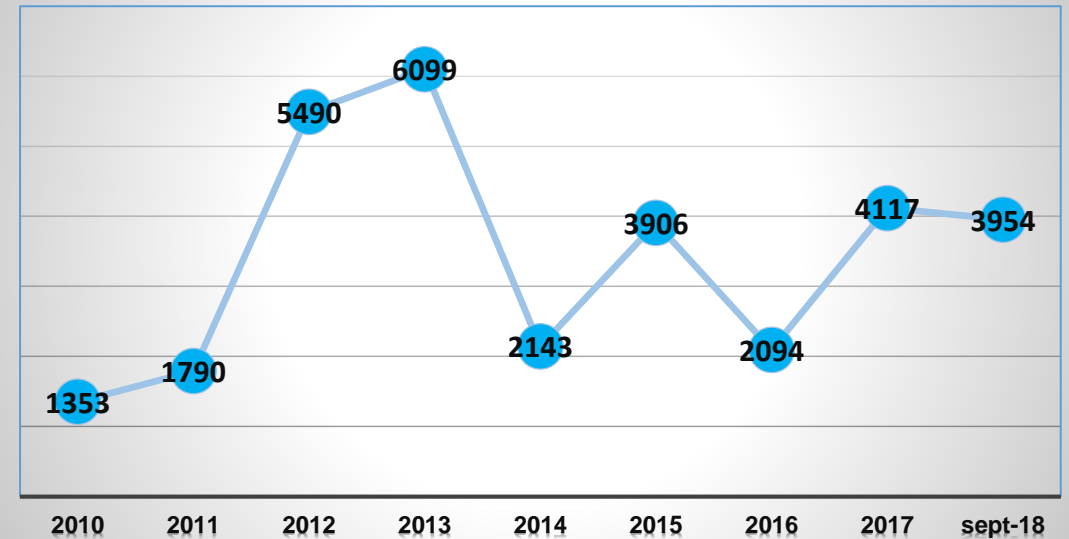

ML PILOTES

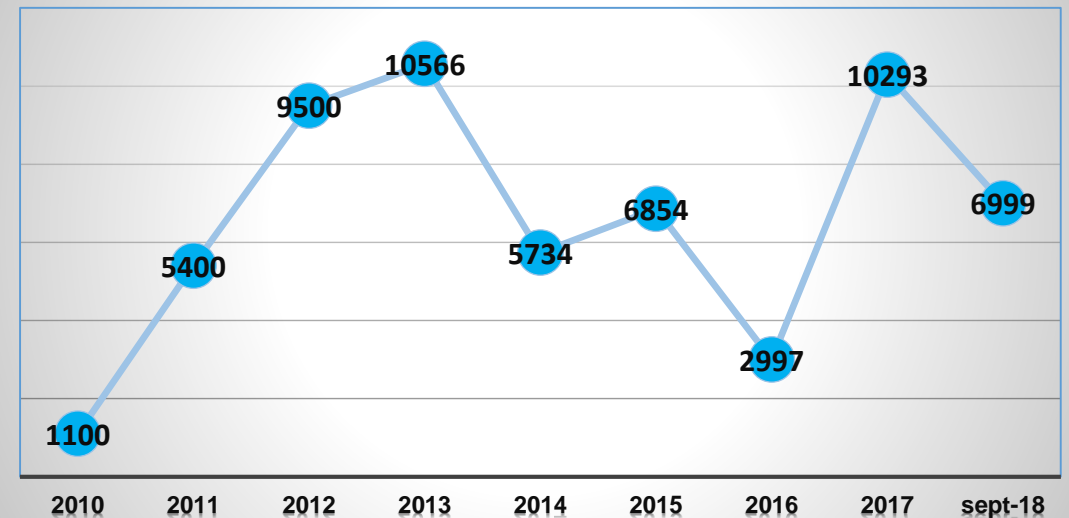

REALIZANDO PROCEDIMIENTOS DE CONTROL DE CALIDAD E INGENIERIA DE FUNDACION ADECUADA PARA EL TIPO DE SUELO SE EVITA ESTOS SINIESTROS





PILOTES **KS**

GEO CONSTRUCCIONES Y MAQUINARIAS C.A

CONTACTANOS

DIRECTOR
ING. ANGEL CUSATI



0414-246.68.64

cusatiangel@gmail.com



GERENTE GENERAL
ING. IVAN ISEA MERCADO

C.I.V. 112.701 / S.V.D.G. 424

Ivan Isea (Pilotaje)

0416-928.31.85

ivanisea75@gmail.com



DATOS GENERALES



0212-519.38.04

aapilotesks@gmail.com



www.pilotesks.com

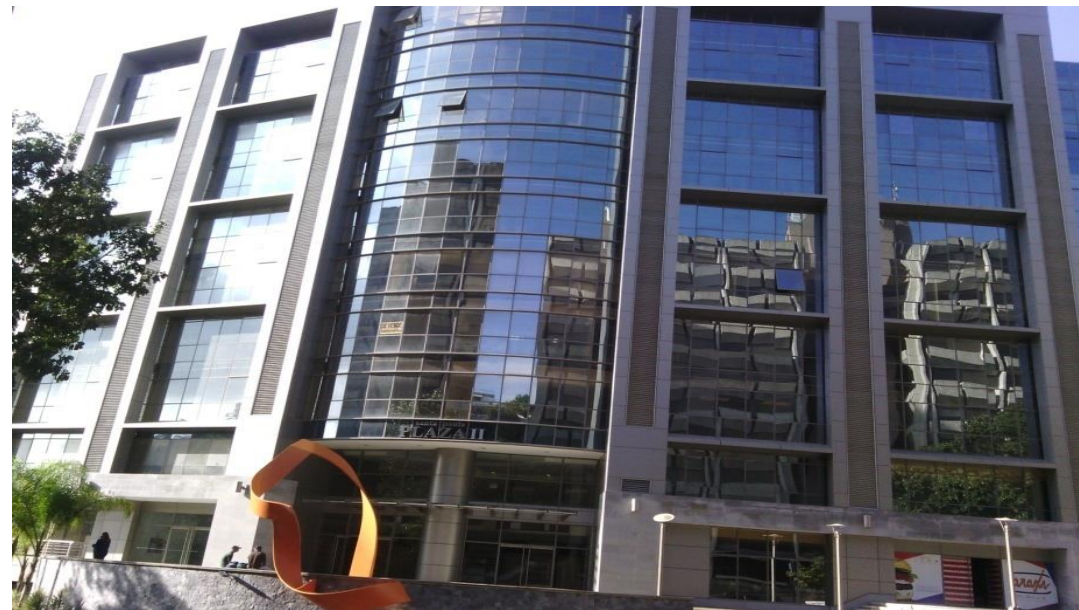

Nuestra Oficinas Administrativas:

Av. Circunvalación del Sol, Edif. Santa Paula Plaza II,
Piso 2, Ofic. 203. Urb. Santa Paula, Caracas, Vzla.